



Motor protection switches	80
Ravel motors	81
Remote thermometers	80
Remote thermostats	80
Time hour meter	80

Motor protection switches

Type OKN



K F

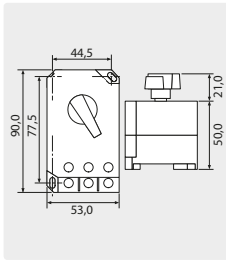

Housing for type OKN

R+M Nr.	working range
901 516	10.0 - 16.0 A
901 522	16.0 - 22.0 A
901 527	22.0 - 27.0 A

R+M Nr.	(M)
901 540	plastic

Time hour meter



cutout

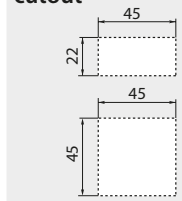

Meter with clip

R+M Nr.	(V)
915 102 4	24 V ~
915 122 0	230 V ~
915 140 0	400 V ~

Remote thermometers

With contact probe and adjustable knob

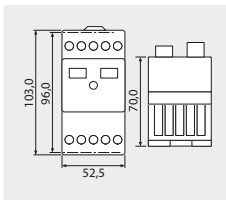

Housing for type OKE 2

R+M Nr.	working range
901 610	6.3 - 10.0 A
901 616	10.0 - 16.0 A
901 625	16.0 - 25.0 A

R+M Nr.	(M)
901 630	plastic

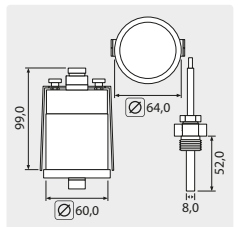

1/2" M. Contact 5 A - 250 V (AC1). Indication of temperature 0 - 120 °C

R+M Nr.	working range	tube length
910 20	0 - 80 °C	1,000 mm

Remote thermostats

Emerson 1536

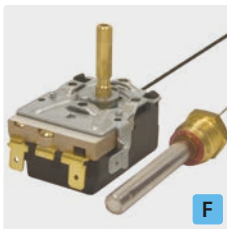

F

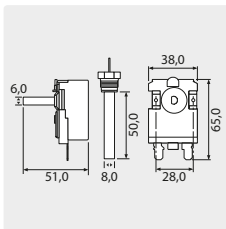

M14 x 1 M. Contact 16 A - 380 V (AC1)

R+M Nr.	working range	tube length
910 16	0 - 160 °C	1,550 mm

Probe with screw

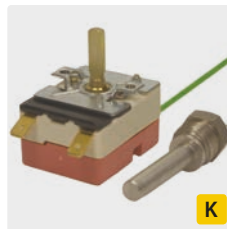

K

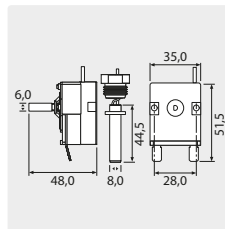

3/8" M. Contact 16 A - 380 V (AC1)

R+M Nr.	working range	tube length
910 12	30 - 150 °C	1,520 mm
910 13	0 - 152 °C	920 mm

Emerson 8654



W

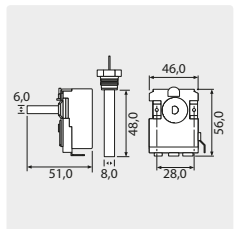

3/8" M. Contact 16 A - 380 V (AC1)

R+M Nr.	working range	tube length
910 15	30 - 150 °C	1,550 mm

Symbols (M) material (A) ampere (V) voltage (W) watt (Ø) diameter (KW) kilowatt (TYP) type (truck) shipment by truck

Ravel motors

Motor with hollow shaft

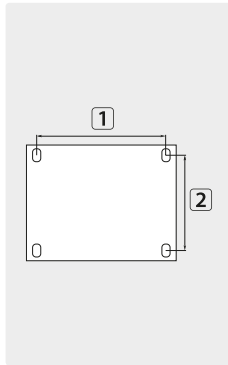

IP54, 1,400 r.p.m.

R+M Nr.	∅	hole size 1 x 2	TYP	V	A	KW
175 001 061	24	140 x 160 mm	H100	400	6.9	3.0
175 001 081	24	140 x 190 mm	H112	400	9.4	4.0
175 001 090	24	140 x 190 mm	H112	400	12.1	5.5
175 001 120	24	140 x 216 mm	H132S	400	15.4	7.5

Motor with solid shaft

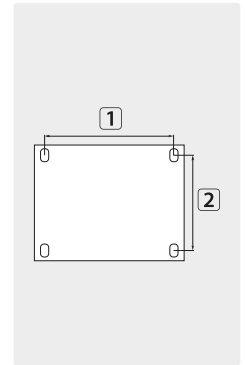

IP54, 1,400 r.p.m.

R+M Nr.	∅	hole size 1 x 2	TYP	V	A	KW
175 002 004	24	140 x 160 mm	H100	400	5.1	2.2
175 002 001	28	140 x 190 mm	H112	400	9.4	4.0
175 002 002	28	140 x 190 mm	H112	400	12.6	5.5
175 002 091	38	140 x 216 mm	H132S	400	16.8	7.5

Flange for hollow shaft motor

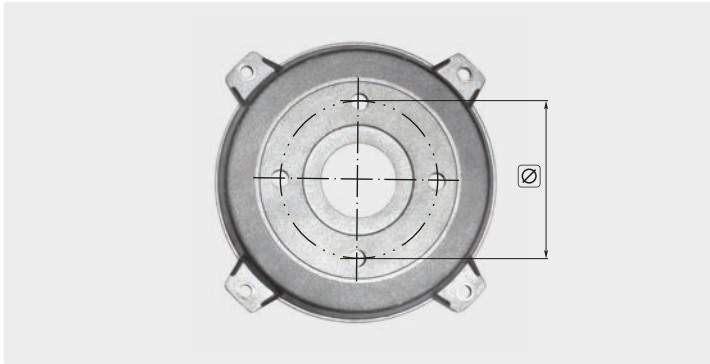

R+M Nr.	TYP	bolt-circle ∅
175 300 306 1	H 100	75 mm
175 300 307 4	H 112	75 mm
175 300 305 1	H 100	87 mm
175 300 305 2	H 112	87 mm

Further versions of Ravel motors are available on request!

Pump/motor assignment on page 42

