

## EN Operating manual

High-pressure cleaner

**LX 2000**

**LX 2500**

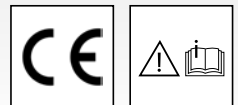

# Operating manual

EN

High-pressure cleaner

**LX 2000**

**LX 2500**

## **Operating manual!**

This manual is a translation of the original manual. Read and conform safety instructions before use! Keep instructions in a safe place for later use and pass them on to any future user.

## Dear customer:

We would like to congratulate you on the purchase of your new high pressure cleaner and thank you for your confidence in our products!

Your choice has fallen on an absolute quality product! Kränzle high pressure cleaners are characterized by their convenient and compact design as well as their high suitability for everyday use.

Highest precision and dimensional accuracy in addition to a technology package consisting of a multitude of details mark the difference when it comes to performance, safety and durability.

In order to facilitate handling of the high pressure cleaner, the following pages are intended to further explain its use. The illustrations may be subject to deviation depending on the type of equipment or accessory of high pressure cleaner purchased by you.

<b>Contents</b> .....	4
<b>Explanatory symbols</b> .....	5
<b>Safety notes</b> .....	6
<b>Description of high pressure cleaner</b> .....	9
<b>General rules</b> .....	11
<b>Functional details</b> .....	13
<b>Putting into operation</b> .....	18
<b>Direct suction</b> .....	22
<b>Taking out of operation</b> .....	23
<b>Small repairs - do it yourself</b> .....	24
<b>Kränzle accessories</b> .....	28
<b>EC declaration of conformity</b> .....	30
<b>Warranty</b> .....	31
<b>Inspection reports</b> .....	32

## Explanatory symbols used in the operating manual



Failure to observe this note may entail environmental damage.



Note on the use of the high pressure cleaner that failure to adhere to the instructions may cause excessive wear or total breakdown of the LX-series.



Warning!  
Failure to observe this note may result in serious injuries!

## Explanatory symbols affixed to the high pressure cleaner



In case of improper use, the high pressure jets can be very dangerous. Do not direct high pressure jet at persons, animals or active electrical equipment or the high pressure cleaner itself.



The high pressure cleaner may not be connected directly to the public drinking water supply network.

User operating the high pressure cleaner should wear the necessary protective clothing, i.e. waterproof clothing, rubber boots, safety goggles, headwear etc. It is prohibited to use the high pressure cleaner in close vicinity to people lacking suitable protective clothing.

Do not spray against matter containing asbestos or other hazardous substances!

Never spray liquids containing solvents like varnish solvents, petrol, oil or similar liquids! There is an explosion hazard due to spraying such materials!

Due to the high pressure jet, damage may occur on the objects to be cleaned, e.g. car tires; therefore, a minimum distance of 30 cm is to be kept!

Prior to putting the high pressure cleaners into operation, check its components (High pressure hose, power supply cables, safety trigger gun) for any damage. Replace defect or damaged components!

Replacement of the power supply cables is only permitted by use of an original power supply cable of the manufacturer and must be performed by a qualified electrician.

The high pressure cleaner is to be properly used. The user is required to adhere to local requirements and to watch out for the persons in the danger zone!

The high pressure cleaner is not intended for use by persons with reduced physical, sensory or mental capabilities, unless such persons are supervised and capable of perceiving the risks involved in the use of high pressure cleaners!

The water drained through the thermo valve is very hot and may cause burns in case of skin contact.

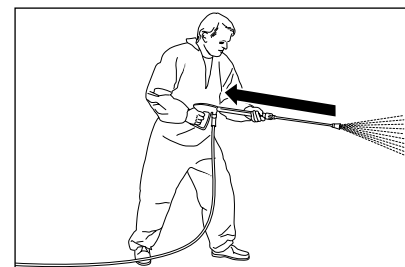

When using high pressure water for cleaning, make sure that there is a clearly noticeable recoil effect on the lance. Therefore ensure a firm footing (see technical data).

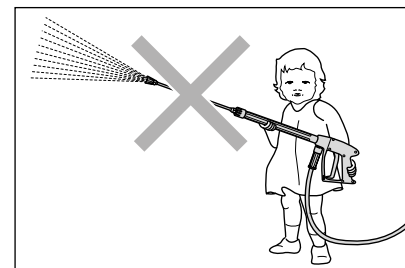

Never allow children or untrained persons to use the high pressure cleaner or to play with it!

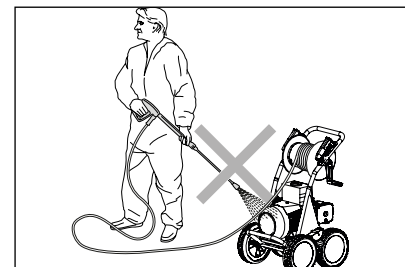

Never direct the high pressure jet at the high pressure cleaner itself!

The high pressure cleaner may not be placed within reach of the high pressure jet spray mist!

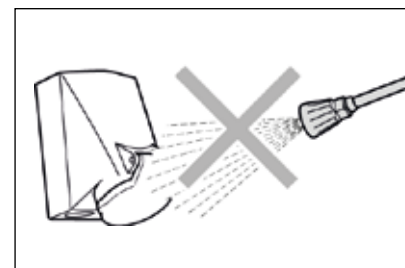

Never direct the high pressure jet at power sockets or any other electrical installations!

Within the working area, all live parts are to be protected from both water jet and spray mist.

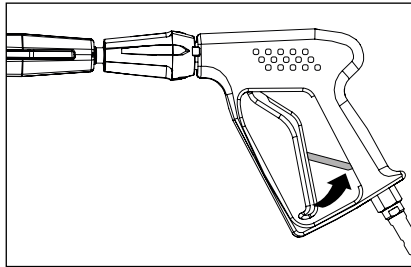

Apply the safety catch on the safety trigger gun after each use in order to prevent unintentional spraying!

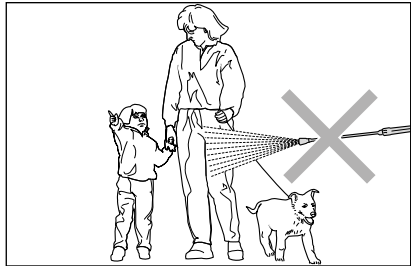

Never direct the high pressure jet at people or animals!

Never direct the high pressure jet at yourself or other persons, not even to clean clothing or shoes.

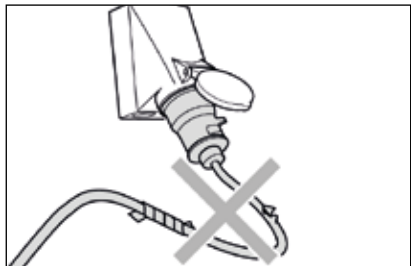

Only use a power supply cable in perfect working order!

Do not damage or improperly repair the power cable (tearing, squeezing, running over, ...).

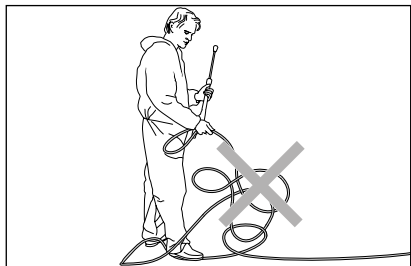

Never pull the high pressure hose if it has formed kinks or "nooses"!

Never pull the high pressure hose over sharp edges!

**Design:**

Both the LX 2000 and the LX 2500 are portable type high pressure cleaners. Please see construction scheme for more details.

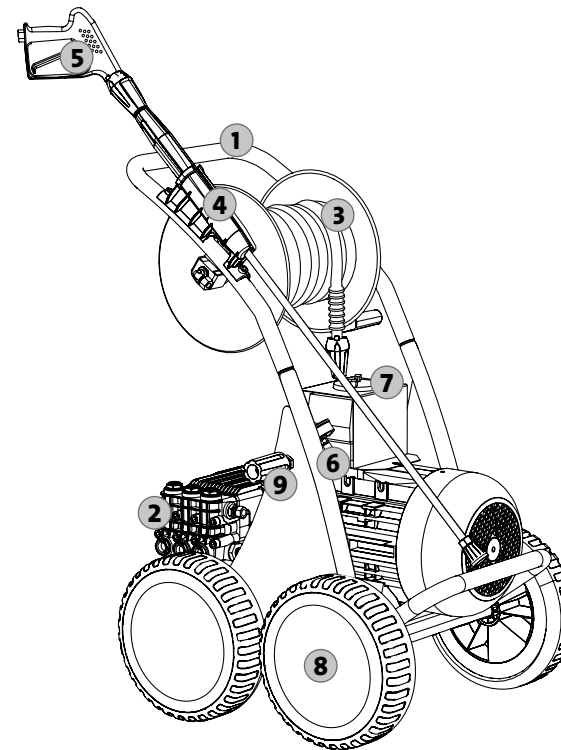

1. Handle
2. Pump head made of brass
3. Hose drum with 20 m steel weave high pressure hose
4. Holders for trigger gun with safety catch with lance
5. Trigger gun with safety catch and plug coupling
6. Large stainless steel pressure gauge
7. On/Off switch
8. Integrated trolley takes rough ground in its stride
9. Infinitely variable pressure and quantity regulation

## This is what you have purchased:

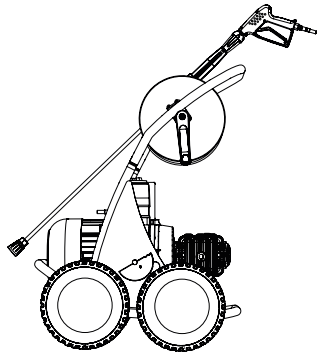

1. High-pressure cleaner  
LX 2000  
LX 2500

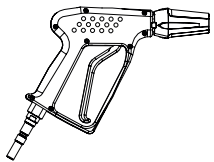

2. Trigger gun with safety catch  
and plug coupling



3. Stainless steel lance with flat jet  
nozzle and quick release coupling



4. Operating manual  
Spare parts list

### Optional:

1000 mm turbokiller with stainless  
steel lance and plug-in nipple  
**LX 2000: Ord. no.: 12430-12**  
**LX 2500: Ord. no.: 12430-18**

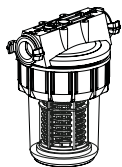
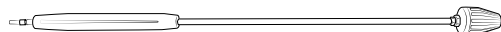

Water inlet filter  
**Ord. no.: 133203**

## Intended use

This high pressure cleaner is to be used solely for high pressure water jet cleaning applications without detergents or low-pressure cleaning work with detergents (e.g. with a foam injector or washing brush).



**Environmental, refuse disposal and water protection regulations must be observed!**

## Inspections

The high pressure cleaner must be inspected according to the “Guidelines for Liquid Spray Devices” at least once every 12 months by a qualified person, to ensure that continued safe operation is guaranteed. The results of the inspection are to be recorded in writing (see Inspection reports).



**High pressure cleaners used for commercial purposes have to be checked by a qualified person at least every 12 months!**

## Accident prevention

The high pressure cleaner is designed for accidents to be impossible if used correctly. The user is to be notified of the risk of injury from hot machine parts and the high pressure jet. The “Guidelines for Liquid Spray Devices” must be complied with.

## Oil change

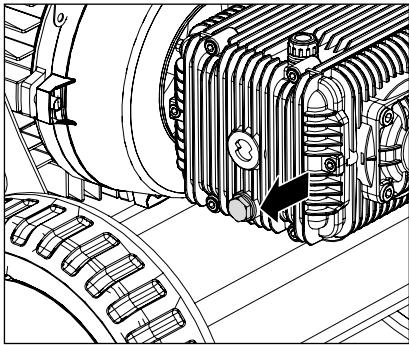

The first oil change should be carried out after approximately **50 operating hours**, then every year or after 250 operating hours. If the oil turns grey or white, you must change the oil. In case of exchanging oil being required, the oil drain screw must be opened above a container and the high pressure cleaner be emptied. The oil is to be caught in the reservoir and disposed of in an approved manner.

### New oil: 1.2 l

Kränzle high-performance transmission oil (Ord. no.: 400932) or Motor oil 10W40.



### Oil leakage

If oil leaks contact your nearest after-sales service (dealer) at once. (environmental damage, damage to the transmission).



**In case of increased humidity or fluctuations in temperature development of condensed water is possible. If the oil turns grey or white, you must change it.**

## High pressure hose and spray device

The high pressure hose and spray device which are part of the LX-series equipment, are made of high quality material and engineered to conform with the operating conditions of the high pressure cleaner and are duly labeled.



If replacement parts are required, only such parts that are authorized by the manufacturer may be used. The warranty is automatically void if spare parts of third-party providers are used! The high pressure hose and spray device must be connected in a pressure-tight manner (without leakage).



The high pressure hose may not be driven over, pulled excessively, or twisted. The high pressure hose may under no circumstances be pulled over sharp edges. Defective high pressure hoses must not be repaired (acc. to DIN 20022) but have to be replaced by new hoses approved by the manufacturer.



**Prior to putting the high pressure cleaner into operation make sure that all safety instructions be observed.**

## Water and cleaning system

Water must be supplied to the high pressure pump under pressure or directly sucked in out of a pressureless container. The water is then forced under pressure by the high pressure pump to the lance. The high pressure jet is formed by the nozzle at the end of the lance.



**Environmental, refuse disposal and water protection regulations must be observed!**

## Safety jet pipe with safety trigger gun

The high pressure cleaner can only be operated when the trigger of the safety deactivation trigger gun's trigger is actuated. When the trigger is pulled, the safety trigger gun opens. The liquid is then transported to the nozzle. The spray pressure increases and quickly reaches the operating pressure. When the trigger is released, the safety trigger gun closes and any further spraying of liquid from the safety jet pipe is prevented. The stainless steel pressure gauge must show 0 bar. The increase in pressure when the safety trigger gun is closed causes the pressure control valve/safety valve to open. The motor is switched off by the pressure switch. The HP pump remains switched on and continues to operate unpressurized via the bypass. When the safety trigger gun is opened, the pressure control valve/safety valve closes, the motor is started and the high pressure pump resumes pressure spraying from the safety jet pipe with the selected operating pressure.



**The safety trigger gun is a safety device. Repairs should only be performed by qualified persons. Should replacement parts be required, use only components authorized by the manufacturer.**

## Pressure control valve/safety valve

The pressure control valve/safety valve protects the high pressure cleaner from a build up of excess pressure, and is designed not to permit an excess pressure to be selected for operation. The limit nut on the handle is sealed with a spray coating. The operating pressure and spray rate can be steplessly adjusted by turning the handle.



**Replacements, repairs, new adjustments and sealing should only be performed by qualified persons.**

## Motor protection switch

Motor is protected against overload by means of a motor protection switch. In case of motor overload or blocking, the motor of the high pressure cleaner switches off automatically. If motor tends to switch off repeatedly, make sure to detect and remedy the cause of the failure.



Replacements and inspection work should only be performed by qualified persons **when the high pressure cleaner is disconnected from the power supply**, i.e. with plug pulled out from the electrical socket.

## Thermo valve

If HP pump is switched on and trigger gun with safety catch is not operated, the HP pump continues operation and transports water in the circuit via the bypass valve. This will heat up the water. For protecting the HP pump against inadmissibly high temperatures, a thermo valve is installed in the bypass circuit which opens at 63 degrees and drains hot water at the bottom of the HP cleaner via a hose.



Pay attention to splash water when operating HP pump in bypass.



### Please note: Lack of water

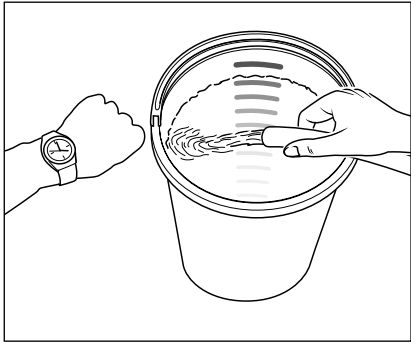

Lack of water occurs more often than you probably believe. The more powerful a high pressure cleaner is the greater is the danger that a lack of water occurs. If there is only an insufficient amount of water available, cavitation (water-gas mixture) arises inside the high pressure pump, which is normally noticed too late or even not at all. **The high pressure pump will be destroyed.** Please check the available quantity of water by filling a bucket with liter scale for one minute.

#### Required minimum quantity of water (see technical data).



**If the metered quantity of water is too small, you have to use a different water connection, guaranteeing the necessary output. Lack of water leads to an accelerated wear of the joints (no warranty).**



**Never let the high pressure pump run dry for more than 60 seconds.**

### Water supply



Please pay attention to the regulations of your waterworks company! In accordance with DIN EN 61770, the high pressure cleaner may not be directly connected to the public drinking water supply lines. A brief connection however is permissible according to DVGW (German Association for Gas and Water Affairs) if a non-return valve with tube ventilator (Kränzle order no. 41.016 4) is built into the water supply. **Once the water has passed through the non-return valve it is no longer considered as drinking water.** Also indirect connection to the public drinking water supply lines is permissible by way of free emission in accordance with EN 61 770; e.g. by using a reservoir with a float valve. Direct connection to a non-drinking water supply line is permissible.

### Insufficient quantity of electricity

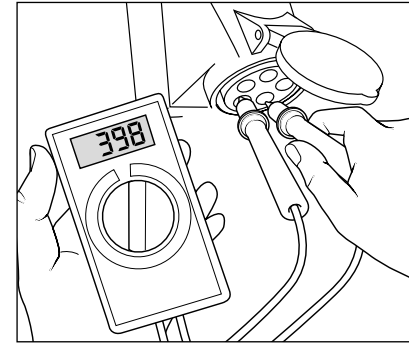

If there are too many collectors in your proximity connected to the network at the same time, the available voltage and the current intensity may decline. Consequently the motor of the high pressure cleaner does not start or even blows. The power supply may also be insufficient if the power supply cable is too long or too thin. If extension cables are too long, this may lead to a voltage drop causing malfunctions or start-up difficulties.



**Check the line fusing and have the voltage and the available current intensity checked by an expert in case of uncertainty (see technical data).**

### Electrical connection

The high pressure cleaner is supplied with a 5 meters long power supply cable. The mains plug must be fitted to a standard grounded socket with a **30 mA** residual current operated device. The socket must be protected with a **16 A** delay action fuse (type C) on the mains side. When using an extension cable, **this must have an earthed lead** which is properly connected to the socket. The conductors in the extension cable must have a minimum cross section of **2.5 mm<sup>2</sup>**. Plug connections must be of a spray-proof design, and may not be located on a wet floor.

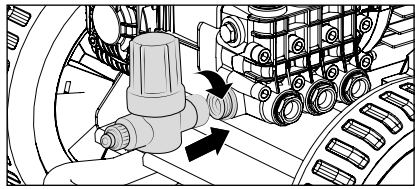

1. Install the water inlet filter (available as an option) at the water inlet.

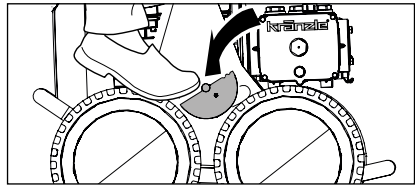

2. For moving the high pressure cleaner to the place of use, please release locking break.  
**The high-pressure cleaner must not be pulled with connected water supply hose!**

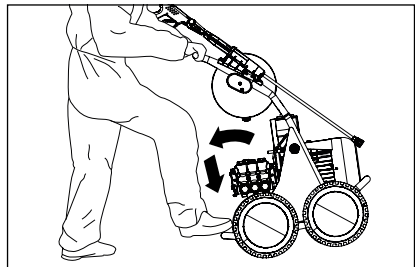

3. The LX-series is a movable high-pressure cleaner with sturdy trolleys ideally suited for difficult terrain.

For steering the high-pressure cleaner put the foot against the tipping support and then pull the device towards you.



**Prior to putting the high pressure cleaner into operation make sure that all safety instructions be observed.**



**Neither set up or operate the LX-series in rooms where there is a risk of fire or explosion nor put it into puddles. Do not use the high pressure cleaner under water. If, none the less, the high pressure cleaner is operated in a hazardous area, the applicable safety regulations are to be observed.**

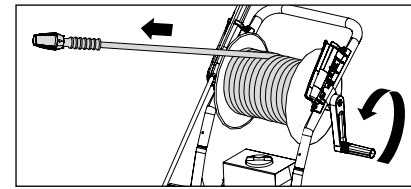

4. Release fixing of hose drum and fully uncoil it after that. (When using high pressure hose extensions take care that the max. length of 20 m is not exceeded!)

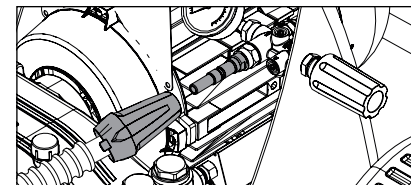

5. **Hose drum must be unrolled completely.**  
Provide for firm and pressure-tight connection of HP hose to pump outlet.

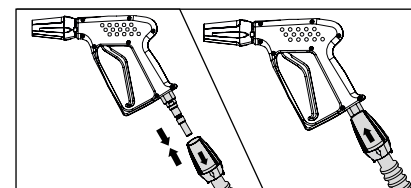

6. Pull back securing sleeve of the HP hose and plug it on trigger gun with safety catch. Release securing sleeve and check for tight fit.

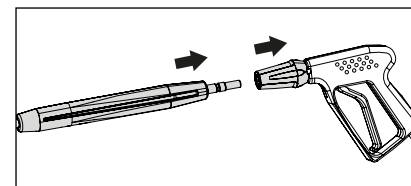

7. First pull back the retaining sleeve of the safety trigger gun, then insert lance into the plug coupling connection of the safety trigger gun.

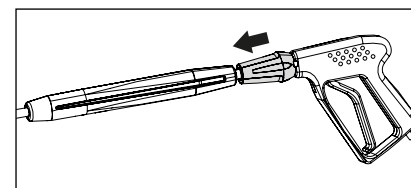

8. After insertion of the lance, release retaining sleeve and make sure that the lance is in a secure position.  
**Grease quick release nipple regularly using acid-free grease.**



**Prior to insertion, check plug coupling connection of lance for cleanliness (sand, dirt ..) and use clear water to clean, if necessary. Impurities may damage the sealing in the plug coupling.**



**Accessories may only be connected to a Kränzle-approved trigger gun with safety catch.**

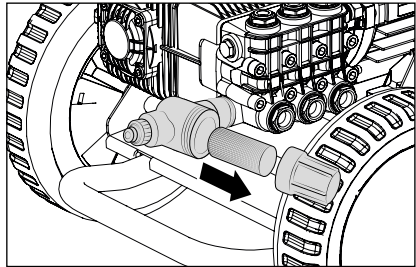

- 9. If using a water inlet filter check it for cleanliness prior to each startup.** Manually unscrew filter bowl, remove sieve and thoroughly rinse and clean with the rest of the parts in clear water. If the sieve is dirty, water cannot get through and pressure will not build up.



**Check the water inlet sieve for damage.**  
Do not operate the high-pressure cleaner using the damaged filter.

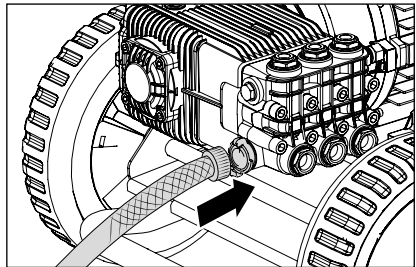

- 10.** Connect the water hose to water inlet sieve. The high-pressure cleaner may be connected to a water mains (1-10 bar pre-pressure) with either cold or hot water (up to 60 °C). The LX-series provides the opportunity of sucking in water out of a container (see direct suction).



**Be careful when using hot water!**  
When running your high-pressure cleaner with hot water of 60 °C raised temperatures occur. Do not touch the metal parts of the high-pressure cleaner without safety gloves!

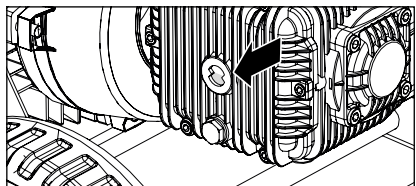

- 11. Each time check oil level at the oil dipstick prior to putting the high pressure cleaner into operation.** Oil level must be visible in the middle of the oil sight glass.

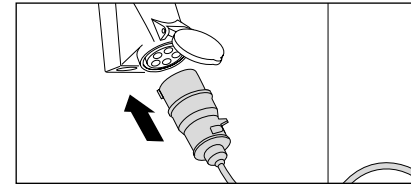

- 12.** Connect to circuit (see technical data).  
The socket must be protected on the mains side with a **16 A delay fuse (type C)**.



**Do not touch the mains plug or any live parts with wet or moist hands.**

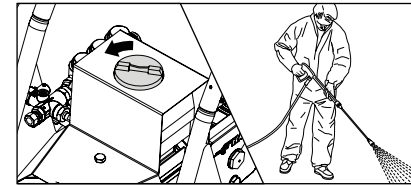

- 13.** Switch on high pressure cleaner with opened safety trigger gun. Bleeding of the high pressure cleaner: Pull and release trigger of safety trigger gun several times. Start cleaning task.

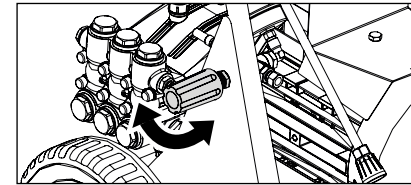

- 14.** Adjust operating pressure infinitely using the rotary handle. The maximum pressure is factory-set.

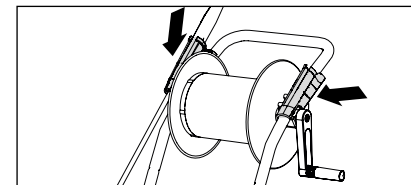

- 15.** The LX series is equipped with 2 supports for the trigger gun with safety catch with lance.

### Direct water extraction

Due to the suction capacity of its high pressure pump (up to 2.5 m suction height, max. hose length 3 m) this high pressure cleaner can suck in water for cleaning purposes from separate containers or ponds.

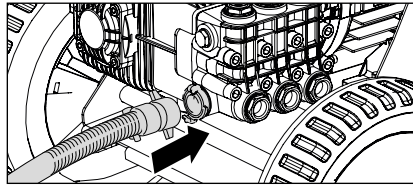

1. Mount suction hose with suction filter (Item no.: 150383).

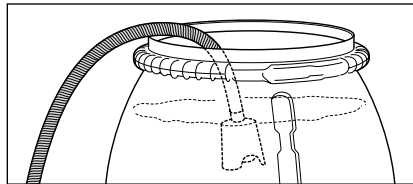

2. Put filled suction hose into the water-filled container and start the cleaning job. **Use clean water only! Never suck in water containing chlorine! Do not suction air!**



**Prior to starting the first suction the high pressure pump and the suction hose has to be filled with water!**

#### Note

Depending on the water quality it may occur after a prolonged standstill that the valves get sticky. Consequently the high pressure cleaner cannot properly suck in water from a container. In this case connect a hose with pressurized water to the pump inlet. Having started the high pressure cleaner the pressurized water opens the valves and the machine resumes sucking in water from the container. Now you can carry on with your cleaning task as usual.



1. Switch off the high pressure cleaner
2. Cut off the water supply
3. Open the safety trigger gun catch briefly until the pressure is released
4. Apply safety catch on the trigger gun
5. Remove high pressure hose and safety trigger gun
6. Emptying high pressure pump: Hold high pressure hose and switch motor on until water jet stops escaping at the outlet.
7. Pull the plug from the socket
8. Clean high pressure hose and wind up without loops, fix hose drum
9. Clean and wind up the power supply cable
10. Clean the water inlet sieve
11. Apply locking brake
12. Store high pressure cleaners in frost-free rooms in winter

### Frost protection

For protecting the high-pressure cleaner against frost please empty it completely. Separate high-pressure cleaner from water supply and switch it on. By opening the trigger gun the high-pressure pump presses water out of the high-pressure cleaner. **However, do not allow the device to operate without water for more than one minute.**

**Problem**

No water from nozzle although the high pressure cleaner is running.  
The stainless steel pressure gauge shows full pressure.

**Cause**

**Most likely the nozzle is blocked.**

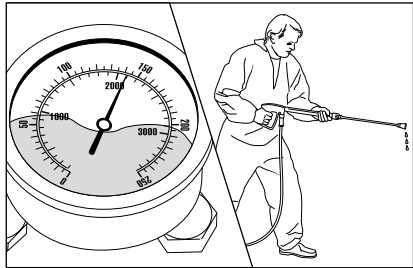

The stainless steel pressure gauge shows full pressure, but from the nozzle comes only little water or no water at all.

(Inside the stainless steel pressure gauge is no water but a filling with glycerin to damp the vibration of the pointer.)

**Proceeding:**

Switch off the high pressure cleaner. Pull plug from the socket. Operate safety trigger gun catch several times to decrease the pressure.

Unplug trigger gun with safety catch and lance first, then rinse high pressure hose to remove possible soiling.

If the problem still exists, take wire (paper clip) and push through nozzle opening. If this procedure is not successful, the nozzle has to be replaced.

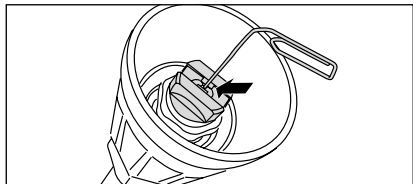

**Pull plug from socket prior to starting any repair work!**

**Problem**

Irregular jet from nozzle.  
The stainless steel pressure gauge shows low pressure.

**Cause**

**Most likely the valves are soiled or sticky.**

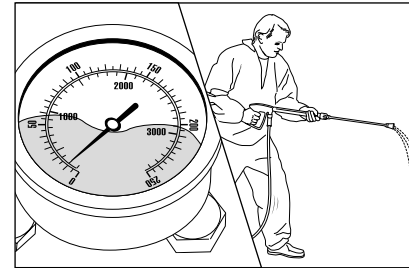

The stainless steel pressure gauge shows low pressure despite fully turned up pressure regulation. The water from the lance comes in squirts. The high pressure hose vibrates.

(Inside the stainless steel pressure gauge is no water but a filling with glycerin to damp the vibration of the pointer.)

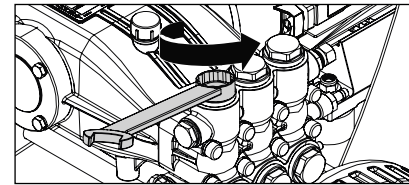

**Proceeding:**

Unscrew all 6 valves, one after the other (hexagonal brass screws, 3 in a row, vertically and horizontally)

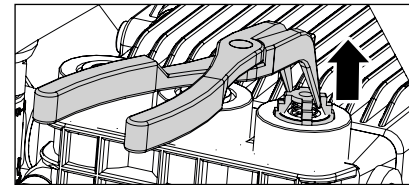

Take out valve body and O-ring by means of needle nose pliers. Check O-ring for damage. In case of a damage the O-ring has to be replaced.

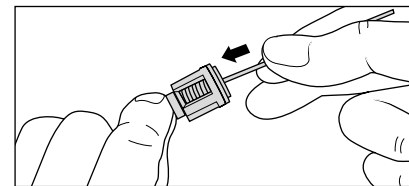

Take a wire (paper clip) and clean valves under running water.

Do not forget the O-ring during reassembly!

**Problem**

After closing the safety trigger gun the high pressure cleaner keeps switching on and off.  
The stainless steel pressure gauge continuously displays full pressure.

**Possible cause No. 1**

**Leakage.**

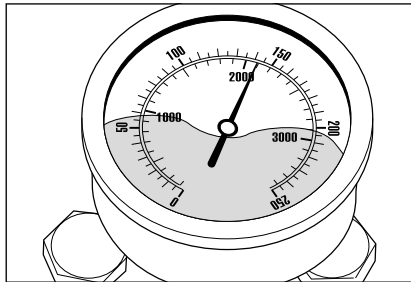

Having closed the trigger gun with safety catch, the high pressure cleaner must shut down and the stainless steel pressure gauge must show „0“ bar. If not shut down and the stainless steel pressure gauge continuously shows full pressure, this could be due to leakage at the high pressure pump, at the pressure switch, at the high pressure hose or at the trigger gun with safety catch.

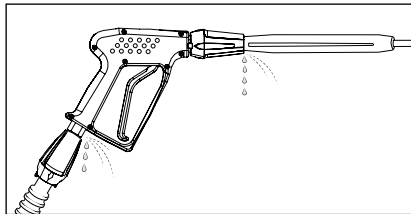

**Proceeding:**

Check connections from the high pressure cleaner to the high pressure hose and from the high pressure hose to the safety trigger gun and also the connection between lance and safety trigger gun for tightness.

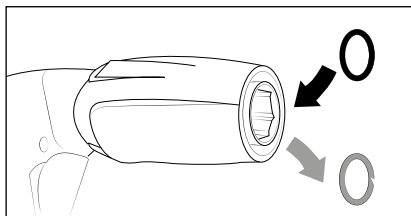

Switch off the high pressure cleaner. Shortly press the trigger of the safety trigger gun to decrease the high pressure cleaner. Unscrew high pressure hose, safety trigger gun and lance and check the O-rings. If the O-rings are damaged they have to be replaced.



**In case of a leakage there is no guarantee for possible consequential damages.**

**Problem**

After closing the safety trigger gun the high pressure cleaner keeps switching on and off.  
The stainless steel pressure gauge continuously displays full pressure.

**Possible cause No. 2**

**The non-return valve is defective.**

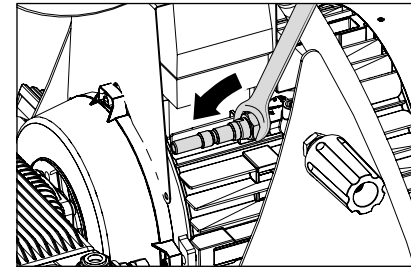

**Proceeding:**

Switch off the high pressure cleaner and pull plug from socket. Stop water supply. Operate safety trigger gun catch several times to decrease the pressure. Unscrew control valve.

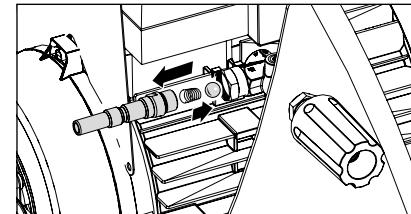

Remove check body and check O-Ring for soiling or damage. Also check seal seat in the control valve for dirt or damage.

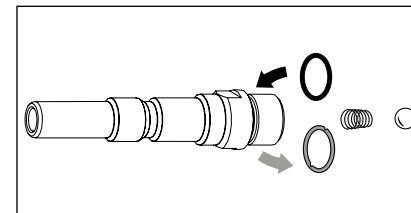

If sealing rings are defective replace O-rings at once.



**There is no guarantee if the high pressure pump is damaged by defective O-rings due to air induction or lack of water (cavitation).**

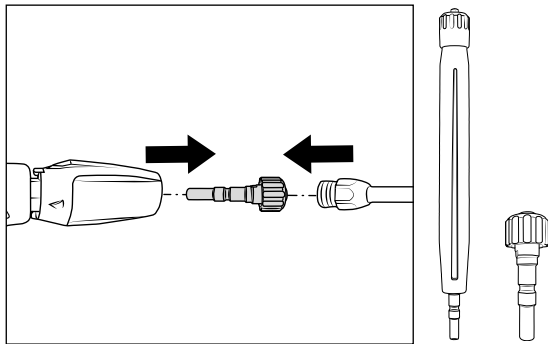

**Adapter for accessories with screw connections**

- With quick release nipple
- For item no.: 12440 (fig. left)
- 400 mm extension
  - With grip plates

Item no.: 12440 (fig. left)  
Item no.: 12441 (fig. right)

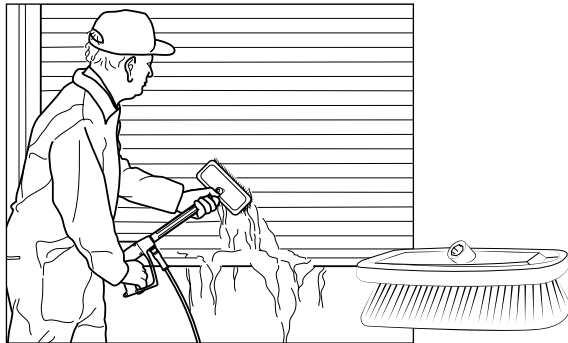

**Washing brush, cross \***

- Brush head L 240 x W 90 mm
- Connection thread 1/4" female thread

\* in combination with adapter only

Item no.: 410500

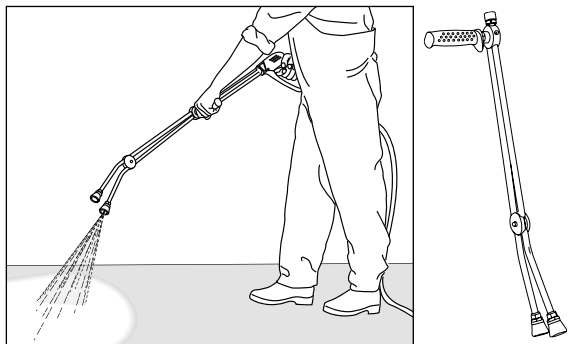

**Double lance**

- With insulated ISO handle
- With plug-in nipple
- Low pressure nozzle D3035 as standard

**LX 2000:**  
Item no.: 12133-D40125

**LX 2500:**  
Item no.: 12133-D40175

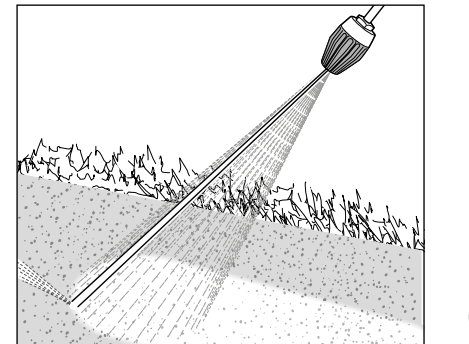

**Turbokiller lance**

- With stainless steel pipe
- 1000 mm
- With plug-in nipple

Item no.: 41570-042

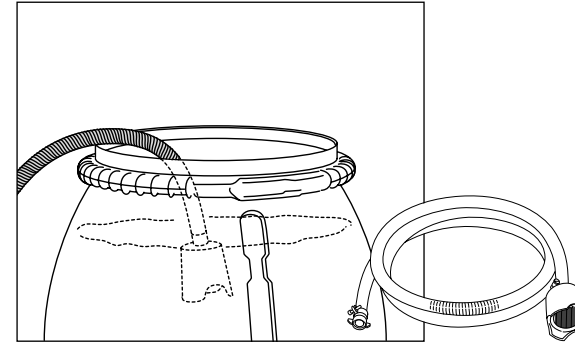

**Suction hose with suction filter**

- With return valve
- Hose length 3 m

Item no.: 150383

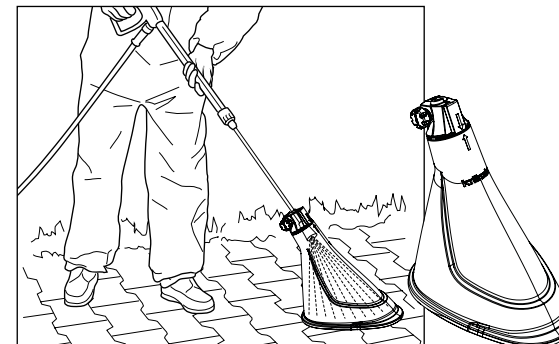

**Splash guard**

- L: 280 mm x W: 190 mm
- For all washing lances

Item no.: 132600



**The high pressure cleaner accessories are safety components!**  
Any warranty will be void if parts not authorised by Kränzle are used.



**Please indicate the technical data of the high pressure cleaner (device type) when placing your order.**

We here by declare that the design of the high pressure cleaners: **Kränzle LX 2000**  
**Kränzle LX 2500**

Nominal flow: **Kränzle LX 2000: 1920 l/h**  
**Kränzle LX 2500: 2490 l/h**

technical specifications available from: **Fa. Josef Kränzle GmbH & Co. KG**  
**Manfred Bauer**  
**Rudolf-Diesel-Str. 20, 89257 Illertissen**

comply with the following guidelines and their amendments for high pressure cleaners: **Machinery directive 2006/42/EC**  
**EMC-directive 2004/108/EC**  
**Noise directive 2005/88/EC,**  
Art. 13 HP water spraying machines  
Annex 3, part B, chapter 27

Sound level measured: **88 dB (A)**  
Sound level guaranteed: **91 dB (A)**

Applied conformity assessment procedure: **Annex V, Noise directive 2005/88/EC**

Applied specifications and standards: **EN 60 335-2-79: 2015**  
**EN 55 014-1: 2006**  
**EN 61 000-3-2: 2014**  
**EN 61 000-3-3: 2013**

Josef Kränzle GmbH & Co. KG  
Rudolf-Diesel-Straße 20  
89257 Illertissen (Germany)

Illertissen, 2017-01-12

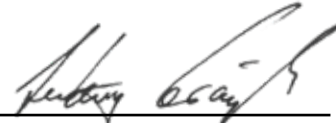

Ludwig Kränzle  
(Managing director)

The warranty obligation of Josef Kränzle GmbH & Co. KG towards the dealer from whom you have purchased this Kränzle high-pressure cleaner (= product) applies to material faults only such as material and manufacturing defects.

Defects attributable to long and frequent use of the product, typically arising due to the age of the high-pressure cleaner and intensity of its use are defined as normal wear in respect of product components. Purchaser's rights to assert claims for such defects are ruled out. Parts subject to wear include in particular the pressure gauge, nozzle, valves, sleeves, high-pressure hose and spray equipment.

The product is to be operated in conformity with this operating manual. The operating manual is deemed to be part of the warranty provisions.

Any changes made to the safety devices of the product or instances of maloperation – such as exceeding the temperature and speed limits, undervoltage, insufficient water supply and sewage water, or failure to use the product for the intended purpose – may result in damage occurring to the product. Such damage is not deemed to constitute any material defect.

Should the use of accessories or spares other than original Kränzle component parts and original Kränzle replacement parts be the cause of defects on our product, this may lead to all warranty claims becoming null and void. Only the use of original Kränzle replacement parts matching the relevant Kränzle high-pressure cleaner provides adequate assurance for safe and trouble-free operation of the Kränzle high-pressure cleaner.

With regard to legal warranty claims, the limitation periods of the respective countries shall apply.

Where warranty claims apply to any other defects, please contact your local dealer, presenting the accessories together with your purchase receipt, or the nearest authorised service centre. This can also be found on the internet under **www.kraenzle.com**.



**High pressure cleaners for industrial use have to be checked by an expert every 12 months!** Inspection report on annually carried out Labour Safety Inspection (UVV) according to the Guidelines for Liquid Spray Equipment. (This inspection sheet serves as proof for the completion of the retest and must be kept carefully!)

Kränzle-test seals: Item no.: UVV200106

Owner: ..... Type: .....  
 Address: ..... Serial no.: .....  
 ..... Repair order no.: .....

Scope of inspection	o.k.	yes	no	repaired
Type plate (on hand)				
Operating manual (on hand)				
Protective covering, Protective device				
Pressure line (tightness)				
Stainless steel pressure gauge (function)				
Float valve (tightness)				
Spraying device (marking)				
High pressure hose / connector (damage, marking)				
Safety valve opens at 10 % / 20 % exceeding				
power supply cable (damage)				
Protective conductor (connected)				
On / Off switch				

Inspection data	determined value	set value
High pressure nozzle		
Operating pressure .....bar		
Switch off pressure .....bar		
protective conductor resistance not exceeded / value		
Insulation		
Leakage current		
Safety trigger gun locked		

**Inspection result (check)**

- The high pressure cleaner was checked by an expert according to the Guidelines for Liquid Spray Equipment, the defects found have been rectified so that the Labour Safety can be confirmed.
- The high pressure cleaner was checked by an expert according to the Guidelines for Liquid Spray Equipment. The Labour Safety cannot be confirmed unless the defects found are rectified by repair or replacement of the faulty parts.

The next retest according to the Guidelines for Liquid Spray Equipment has to be carried out by: Month ..... Year .....  
 Place, Date ..... Signature .....

**High pressure cleaners for industrial use have to be checked by an expert every 12 months!** Inspection report on annually carried out Labour Safety Inspection (UVV) according to the Guidelines for Liquid Spray Equipment. (This inspection sheet serves as proof for the completion of the retest and must be kept carefully!)

Kränzle-test seals: Item no.: UVV200106

Owner: ..... Type: .....  
 Address: ..... Serial no.: .....  
 ..... Repair order no.: .....

Scope of inspection	o.k.	yes	no	repaired
Type plate (on hand)				
Operating manual (on hand)				
Protective covering, Protective device				
Pressure line (tightness)				
Stainless steel pressure gauge (function)				
Float valve (tightness)				
Spraying device (marking)				
High pressure hose / connector (damage, marking)				
Safety valve opens at 10 % / 20 % exceeding				
power supply cable (damage)				
Protective conductor (connected)				
On / Off switch				

Inspection data	determined value	set value
High pressure nozzle		
Operating pressure .....bar		
Switch off pressure .....bar		
protective conductor resistance not exceeded / value		
Insulation		
Leakage current		
Safety trigger gun locked		

**Inspection result (check)**

- The high pressure cleaner was checked by an expert according to the Guidelines for Liquid Spray Equipment, the defects found have been rectified so that the Labour Safety can be confirmed.
- The high pressure cleaner was checked by an expert according to the Guidelines for Liquid Spray Equipment. The Labour Safety cannot be confirmed unless the defects found are rectified by repair or replacement of the faulty parts.

The next retest according to the Guidelines for Liquid Spray Equipment has to be carried out by: Month ..... Year .....  
 Place, Date ..... Signature .....

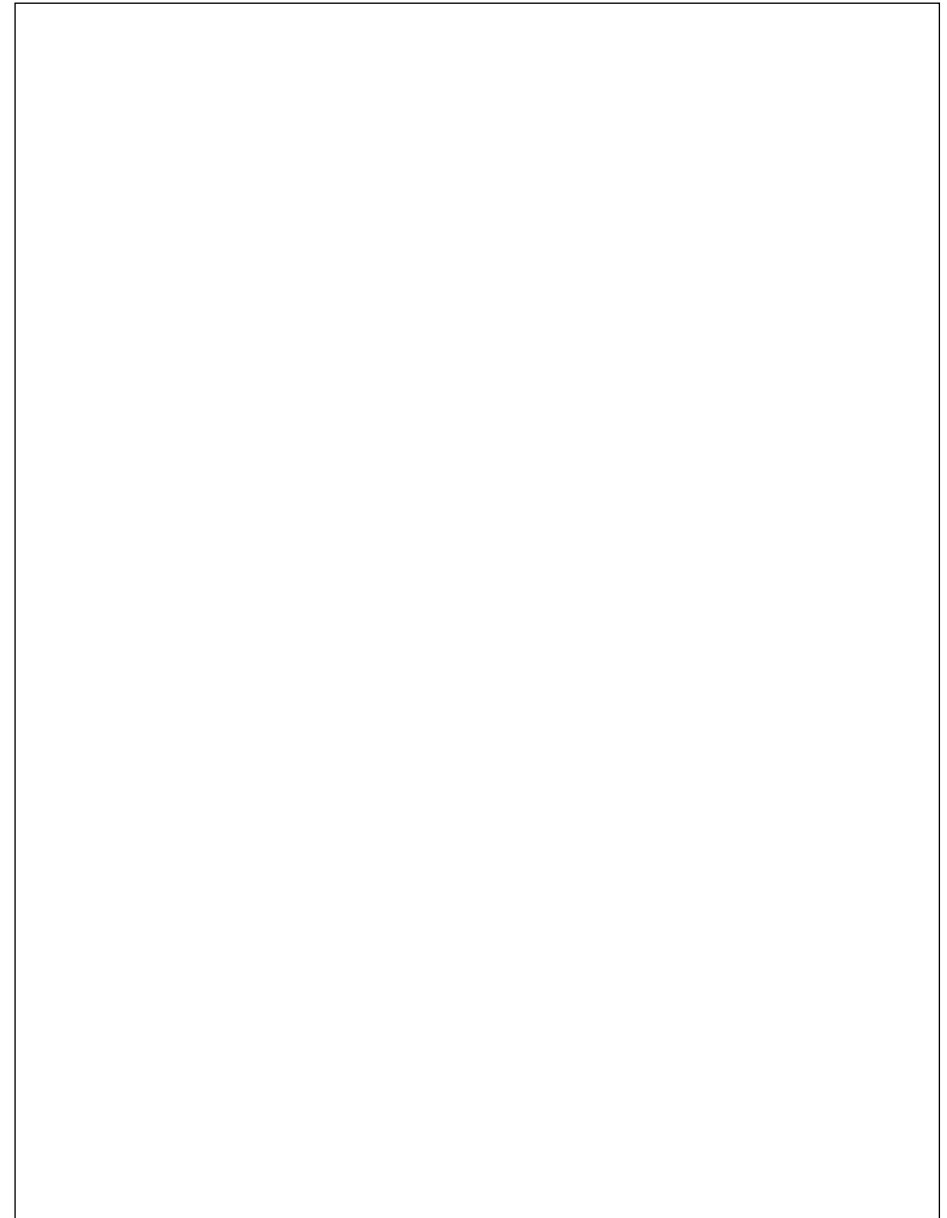
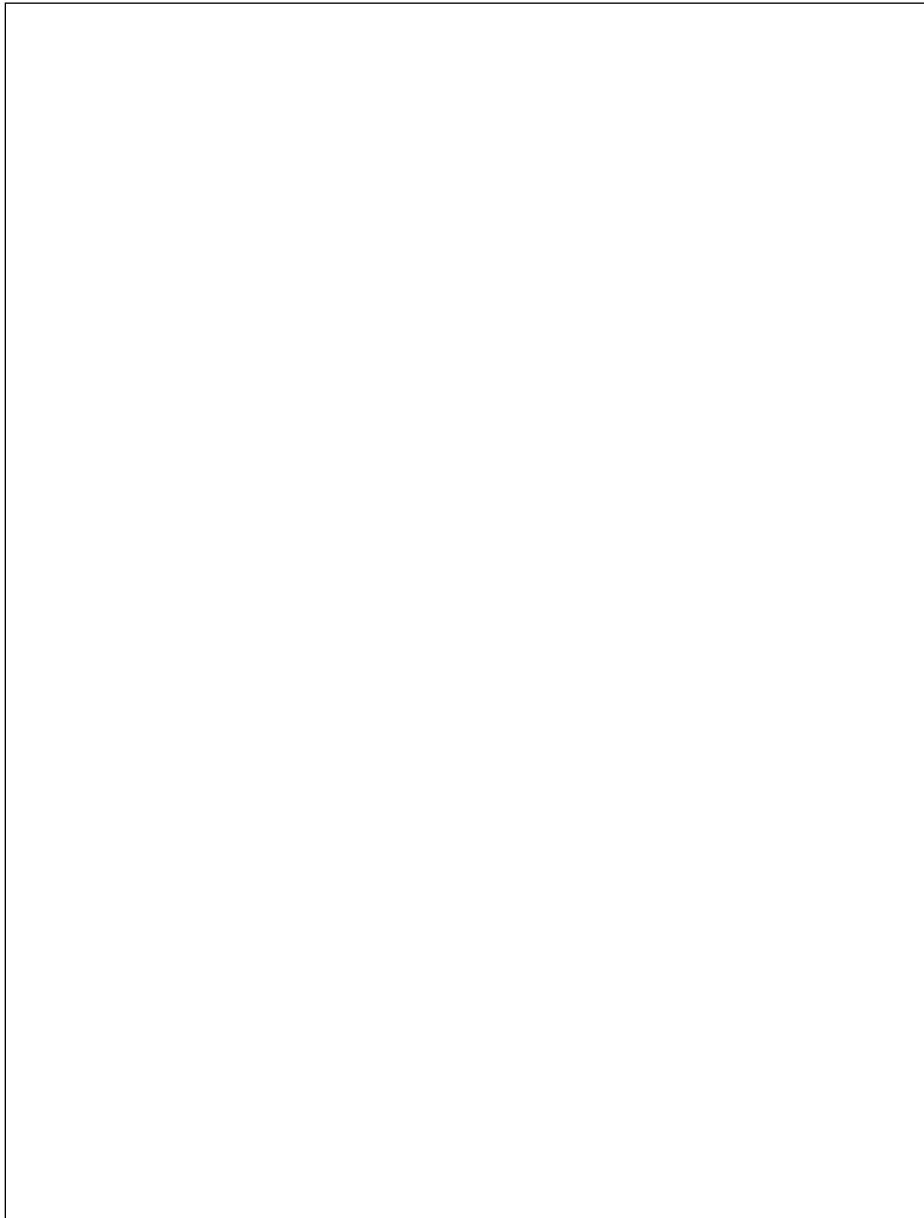

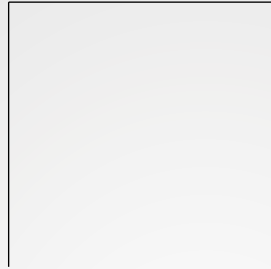

**Josef Kränzle GmbH & Co. KG**

Rudolf-Diesel-Straße 20  
89257 Illertissen (Germany)

[sales@kraenzle.com](mailto:sales@kraenzle.com)

© Kranzle 10.01.2019 / Ord. no.: 306180 / Subject to technical modifications and errors.

■ **Made**  
■ **in**  
■ **Germany**